

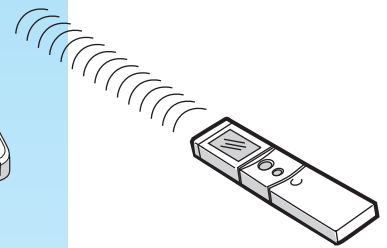

40 GKX

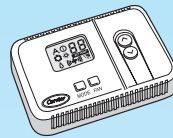
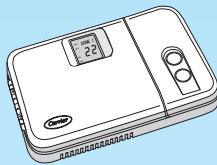
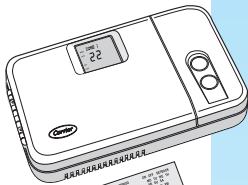
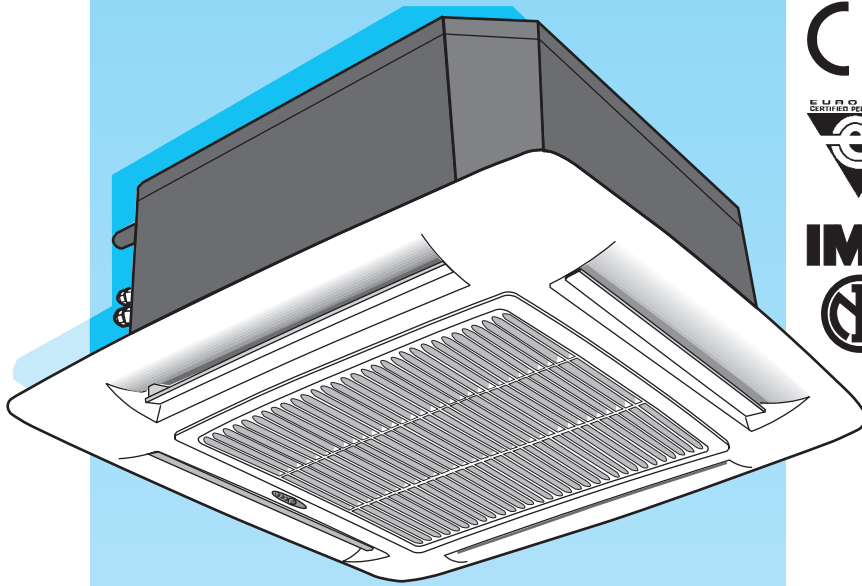

OWNER'S MANUAL

40 GKX

Split system “Global cassette” indoor unit

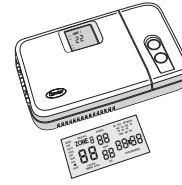
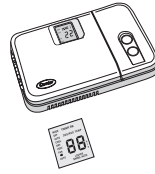
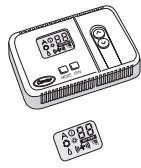
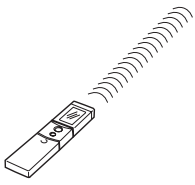

IR Remote Control “Room Controller” “Group Controller” “Zone Manager”

The unit can be used with infrared Remote Control, with the Carrier “Room Controller” or “Group Controller” remote control. Some units can be used also with the Carrier “Zone Manager” remote control. Infrared control instructions are contained in the present manual. Remote controls instructions are contained in the relevant manuals.

The installation instructions for both the indoor and the outdoor unit are given in the manuals for each unit.

Contents

	Page
General information	2
System description	2
Unit LEDs and controls	3
Periodical checks	3
Optimum comfort and minimum power consumption	4
Correct cleaning	4
Before a long shutdown period	4
Infrared remote control	5
Display of the selected functions	6
Unit protection devices	6
Use of the remote control	7/8
Troubleshooting	9

40 GKX

General information

Unit operation and maintenance

Read this instruction manual thoroughly before using the unit.

- This unit complies with the low-voltage (EEC/73/23) and electro-magnetic compatibility (EEC/89/336) directives.
- Check that the mains power supply has been connected to the outdoor unit.
- Check that the mains power supply voltage and frequency are as required for the unit; the power source must be sufficient to operate all other appliances connected to the same line.
- All operation and maintenance manuals must be carefully looked after and kept with the equipment, should the unit change owners.
- Check that all current national safety code requirements for the installation have been followed. **In particular, ensure that a properly sized and connected ground wire is in place.**
- Only use the unit for factory approved applications: the unit cannot be used in laundry premises.
- Do not use damaged equipment. In case of malfunction, turn the unit OFF and disconnect the mains supply.
- Disconnect the mains power supply prior to any maintenance operations or prior to handling any internal unit parts.
- The manufacturer declines any liability for damage resulting from modifications or errors in the electrical or refrigerant connections, made during the installation, or from improper use of this equipment. This will invalidate the unit warranty conditions immediately.
- Failure to observe electrical safety codes may cause a fire hazard in the event of short circuits.
- This unit will only work safely and correctly, if installed and tested by qualified personnel.

- Do not open the remote control to avoid possible damage. In case of malfunction contact a qualified service engineer.
- This unit contains moving parts. Ensure that these parts are kept out of the reach of children.
- Maintain the room temperature at general comfort conditions, especially when children, elderly or handicapped persons are present.
- In order to ensure correct use, the air conditioner must operate within the temperature limits indicated in the "Operating Limits" table, included in the outdoor unit installation manual. Failure to observe these limits may cause unit malfunction or water leakage.
- Inspect equipment for damage during transport. In case of damage file an immediate claim with the shipping company.
- This equipment contains ozone depleting substances. Non-routine maintenance of the refrigerant circuit must only be carried out by qualified personnel.
- **All of the manufacturing and packaging materials used for this appliance are biodegradable and recyclable.**
- Dispose of the packaging material in accordance with local requirements.
- This equipment contains refrigerant that must be disposed of correctly. When disposing of the unit at the end of its operational life, take the unit to an authorised waste disposal centre, or to the original equipment dealer, for correct disposal procedures.

WARNING:

Do not switch OFF the split system by disconnecting the electric power supply. The unit must always be switched OFF using the remote control.

System description

- A. Outdoor unit
- B. Indoor unit
- C. Remote control (if foreseen)

- 1. Air return
- 2. Air filters
- 3. Air supply
- 4. Operation indicator light and receiver of remote control signals
- 5. Nameplate
- 6. Interconnecting tubing
- 7. Condensate drain (open)

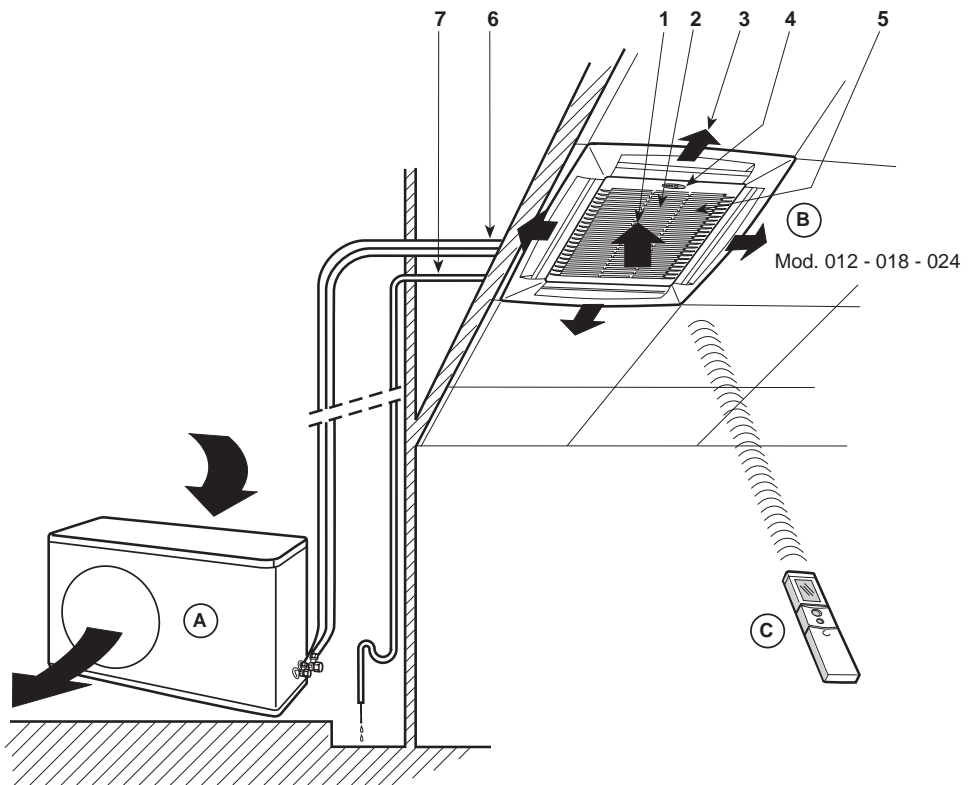

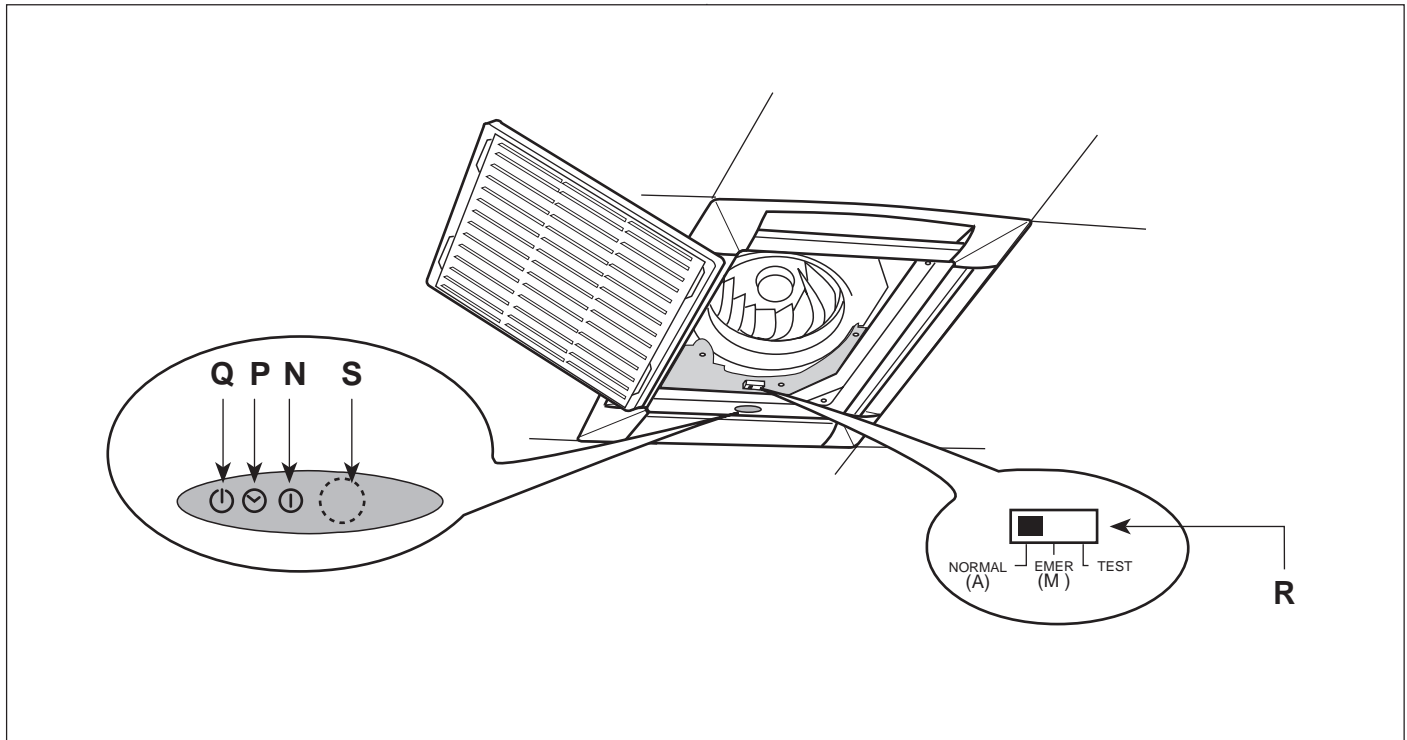

N ① **Green LED:** ON/OFF signal.

P ⌚ **Yellow LED:** timer ON, when illuminated.

Q ⚡ **Red LED:** when illuminated, one of the unit protection devices is activated.

R **Operation switch (it can be used only by authorized installation or service personnel):** three position switch for "normal" (A), "emergency" (M) or "test" operation.

"Normal position" (A): for standard unit operation.

"Emergency position" (M): for use when the infrared control does not work (e.g. - exhausted batteries) or is lost. With the switch in this position unit will keep the room temperature at 23°C under the following conditions:

- Fan speed: automatic
- Deflecting louvres: automatic
- Timer mode: disabled

During emergency operation the unit cannot receive signals from the remote control.

After remote control operation has been reset, return the switch to the "Normal" position.

"Test position": (it can be activated by opening the control panel). When activated the unit will run in the cooling mode and can be switched OFF by pressing any button on the remote control or returning the button to the normal position.

S **Signal receiver from the remote control.**

NOTES:

- When indicator N ① flashes, there is a unit malfunction.
- When indicator P ⌚ flashes, the power supply has been interrupted; this indicator is illuminated only when the timer mode has been activated.
- When indicator Q ⚡ is illuminated, one of the unit protection devices has been tripped.
- **The table "unit protection devices" shows the protection devices included in the unit. An activated protection device is not a sign of unit or system malfunctioning. After a certain time (which differs for each protection device) the air conditioner will automatically return to normal operation.**

Table I: Periodical checks

Indoor unit	Every 6 months	Every year
Clean air filter (2)	• (1)	
Clean condensate drain pipe (2)	•	
Change the remote control batteries (if foreseen)		•
Outdoor unit	Every 6 months	Every year
Clean outdoor coil from inside (2)		•
Blow-clean electric parts (2)		•
Check tightness of electric connections (2)		•
Clean fan wheel (2)		•
Check tightness of fan unit (2)		•
Clean drainage pan (2)		•

For efficient air conditioner operation carry out the checks and maintenance as indicated. Recommended maintenance intervals may vary depending on the installation environment, e.g.: dusty zones, etc.

(1) Increase frequency in dusty zones.

(2) **Operations to be carried out by qualified service personnel. See "Installation Manual".**

40 GKX

Optimum comfort... - Correct cleaning - Before a long shutdown period

Optimum comfort and minimum power consumption

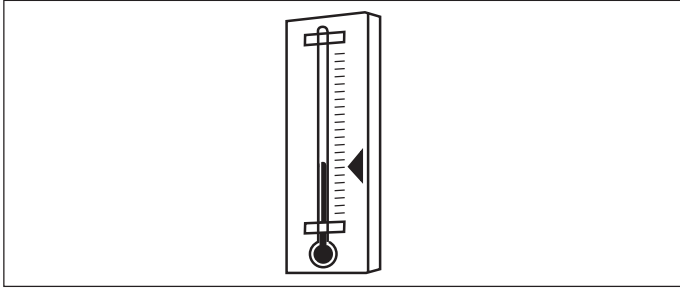

Keep room temperature at a comfortable level.

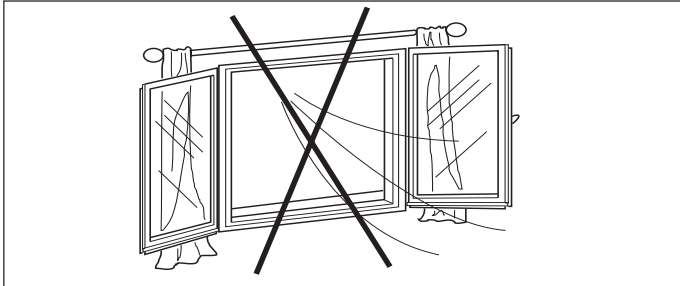

Only open doors and windows when strictly necessary.

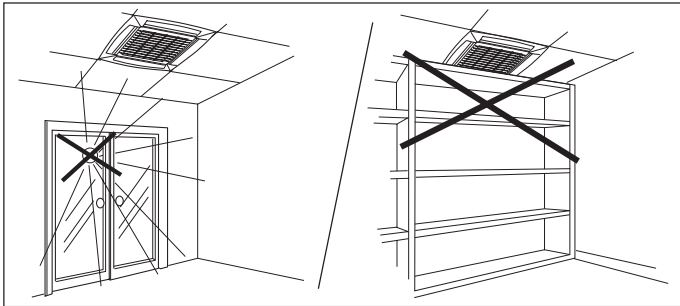

When cooling, avoid direct sunlight in the room: if possible, draw the curtains or close the shades.

Do not obstruct the air intake or outlet of the indoor unit. Obstructions will cause a reduction in the air flow and the conditioning effect, resulting in unit malfunction.

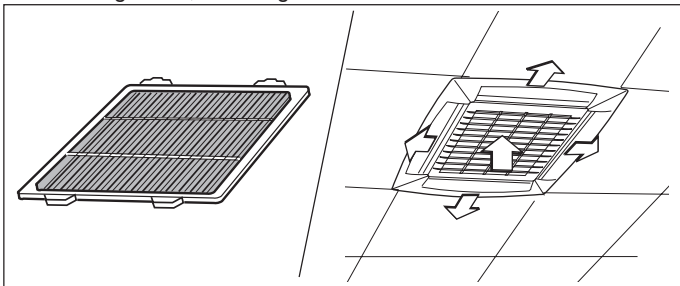

Ensure that the air filters are clean. Ensure that the air distribution in the room is uniform by properly adjusting the air flow direction.

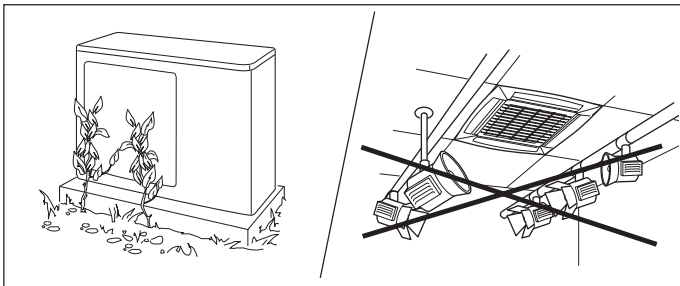

Periodically clean the area surrounding the outdoor unit and the air intake, in order to avoid reduced air circulation. Keep heat sources away from the unit: panels may be damaged.

Correct cleaning

- Turn the unit OFF and switch the main supply OFF.

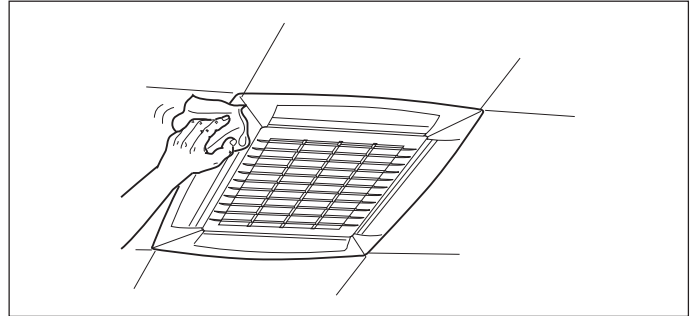

Use only a clean, damp cloth and a mild detergent. Do not use flammable liquids, solvents or abrasive powders that may result in damage to the panels. Use only a dry cloth to clean the remote control.

Before a long shutdown period

Ask to clean the filter and replace it in the unit.

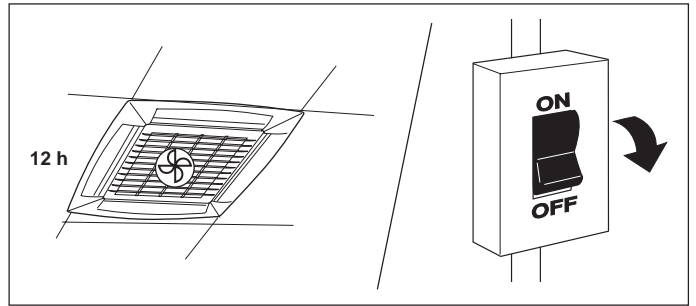

Keep the unit in operation for half a day in the ventilation (fan only) mode in order to dry all internal parts. Switch the unit OFF and wait for at least 3 minutes before switching OFF the main electric supply.

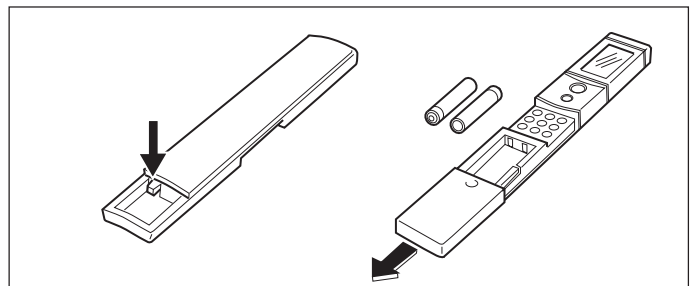

Remove the batteries from the remote control (if foreseen).

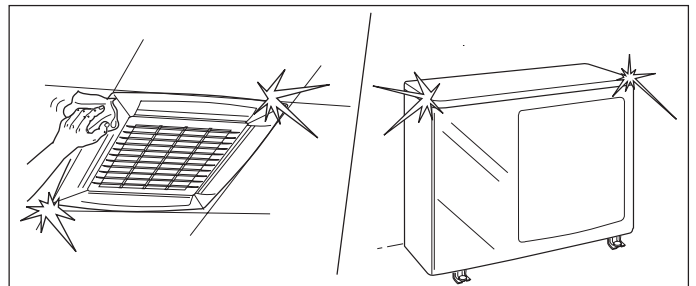

Clean indoor and outdoor units.

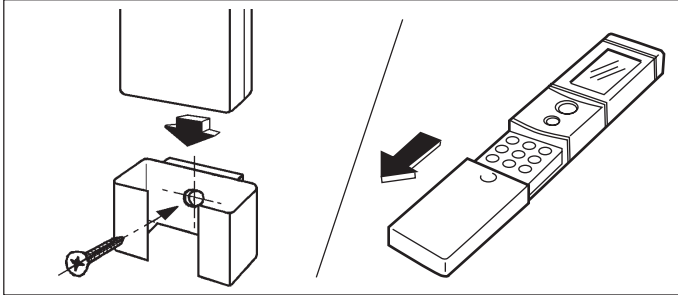

Fix the remote control holder to the wall, using the screw.
The remote control operates with two IEC LR03-type 1.5 V non re-chargeable batteries. A fading display and reduced remote control operating range indicate that the batteries are exhausted.

How to insert the batteries:

The remote control batteries contain contaminating elements. When exhausted, they must be disposed of in accordance with local requirements.

Open the sliding cover.

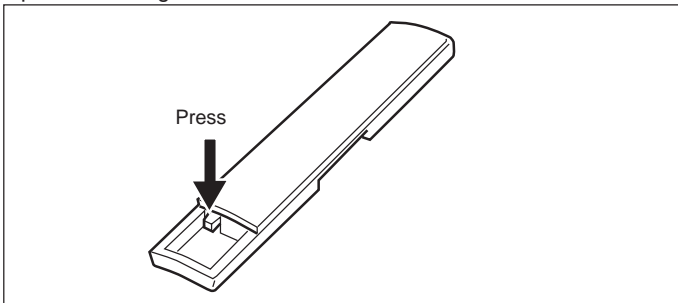

Remove the cover by pressing on the plastic catch on the rear of the remote control.

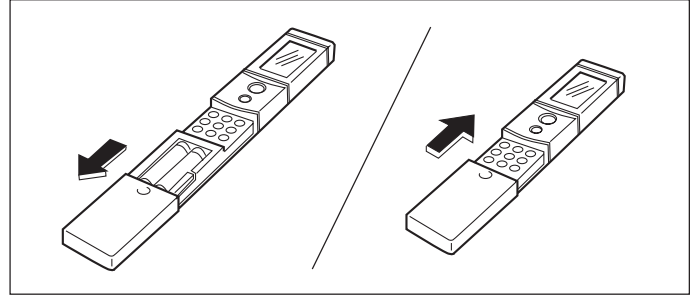

Insert the batteries, paying attention to the correct polarity indicated in the battery compartment; replace the cover.

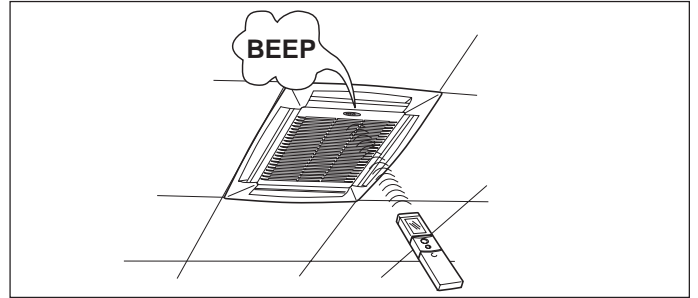

The maximum operating range for the remote control is approximately 6 meters. No obstructions (e.g.: curtains or plants) should be positioned between the remote control and the unit.
Direct sunlight on the unit receiver may interfere with good signal reception. The remote control must be directed toward the unit receiver when pressing the buttons of the desired functions. A "beep" will indicate that the signal has been received. If the signal has not been received, renewed transmission is necessary by pressing any of the buttons E, F, L or J under the sliding cover.
After the "beep" signal, check the function displayed on the remote control readout and adjust or modify the selection made, if necessary. During signal transmission symbol 1▲ will appear on the display. When symbol 1▲ is illuminated it is not possible to send other signals.
In order to send a new signal, check that symbol 1▲ is OFF.

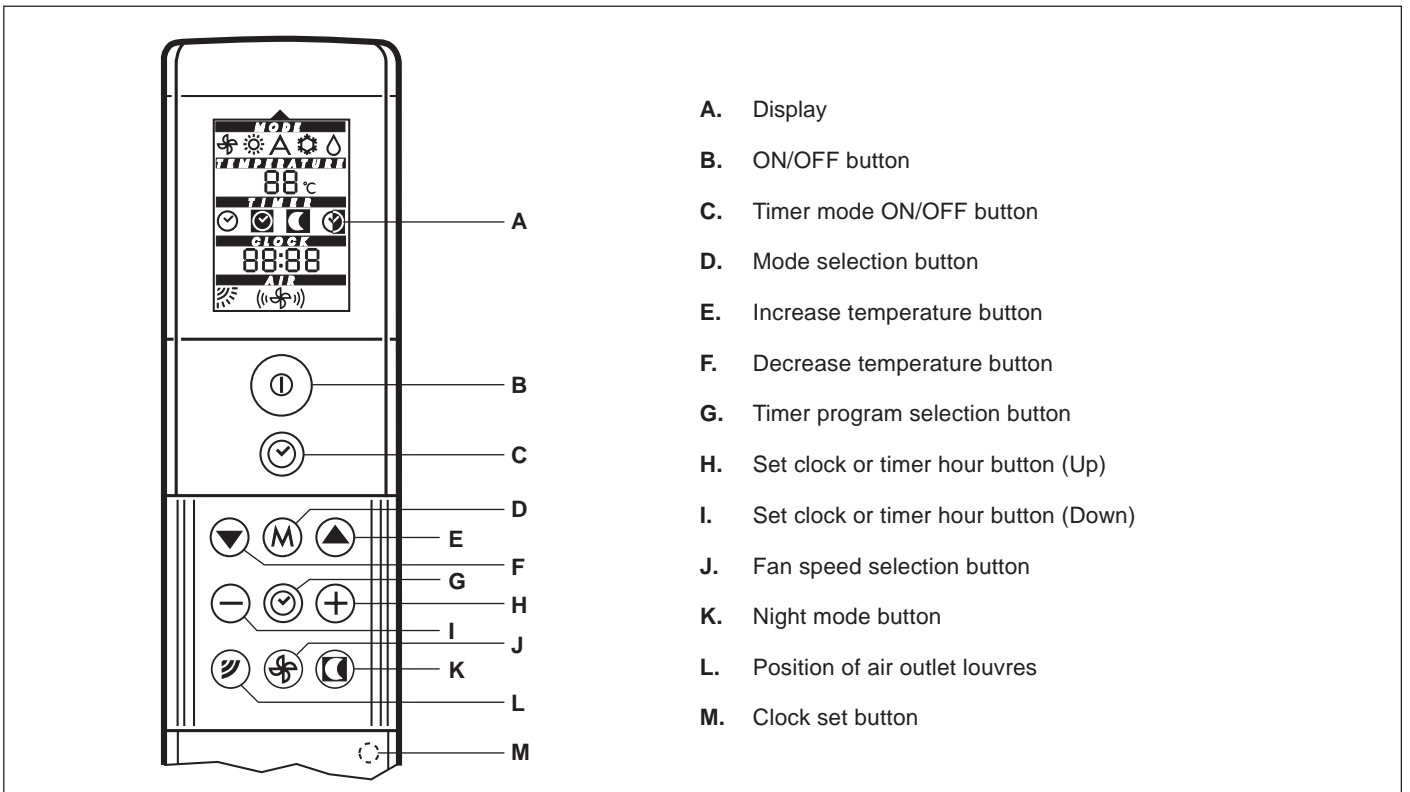

40 GKX

Display of selected functions

The diagram shows the control panel with the following elements and their corresponding numbers:

- 1. Signal transmission symbol (arrow)
- 2. MODE label
- 3. Fan icon
- 4. Sun icon
- 5. 'A' icon
- 6. Gear icon
- 7. Water drop icon
- 8. TEMPERATURE label
- 9. 88°C display
- 10. TIMER label
- 11. Checkmark in circle icon
- 12. Checkmark in square icon
- 13. Moon icon
- 14. Checkmark in circle with arrow icon
- 15. CLOCK label
- 16. 88:88 display
- 17. AIR label
- 18. Fan speed icon
- 19. Louvre icon

1. Signal transmission symbol
2. Operating mode display
3. Dehumidification only
4. Cooling and dehumidification
5. Automatic
6. Heating
7. Ventilation (fan only)
8. Temperature display
9. Temperature selected
10. Timer operating mode display
11. Combined timer start/stop program
12. Night stop function
13. Stop program
14. Start program
15. Clock display
16. Actual time or programmed start/stop time
17. Air function display
18. Fan speed
19. Air outlet louvre operation



Table II: Unit protection devices

Type of protection	Condition for activation
Cold draft prevention (active on heating)	With fan in AUTOMATIC  : indoor fan OFF and red LED on selected.
Defrost cycle (active on heating)	Indoor and outdoor fan OFF and red LED on louvres in a different position from that selected.
Electric heater protection (unit with electric heater only)	Fan will stop for 30 sec. after unit is turned OFF (red LED on).
Freeze-up protection (active on cooling and dehumidification)	Compressor and outdoor fan OFF
Against frequent compressor cycling	Compressor OFF for about 3 minutes



WARNING:

Models with electric heaters: the unit is fitted with two thermostats - one with automatic reset and one with manual reset. If the manual thermostat also trips the circuit, investigate and correct the cause. Switch OFF and ON the power supply to the electric heaters in order to reset the thermostat. During heat pump operation the unit will undergo several defrost cycles to eliminate any ice that may have collected on the outdoor unit in very low ambient temperatures. During these cycles, the indoor fan is automatically stopped and cannot be switched on until the defrost cycle is completed.

Start/stop (button B)

When the air conditioner is not in operation, the remote control readout will only display the actual time (if other symbols are illuminated, turn the remote control OFF by pressing button B ). Press button B  to start the air conditioner; indicator N  on the unit will illuminate; the last selected and memorised functions will be shown in the display:



the unit will operate according to the functions selected.

If the unit does not acknowledge the starting signal by emitting a "beep" sound, and indicator N  does not illuminate, the remote control must be turned OFF (by pressing button B ) and the starting operation must be repeated.

Press button B  to stop the air conditioner; all indicators on the unit will be switched OFF, and the remote control will only display the actual time.

If the unit does not stop, turn the remote control ON (by pressing button B ) and repeat the operation. In certain special operating conditions the fan will continue to run for 30 seconds after the unit stops:

in this event indicator light Q  on the indoor unit will illuminate.

If button B  (air conditioner starting) is pressed immediately after a stop, the compressor will not start for 3 minutes due to the inherent protection against frequent compressor cycling; in this case indicator light Q  on the unit will also illuminate.

The unit will only emit a "beep", when the signals are received correctly.

Timer mode On/off (button C)

This button allows the air conditioner to operate in the TIMER mode according to the programs selected with button G .

When this function is ON, indicator light P  on the unit is illuminated.

After a power failure, indicator light P  will flash and the unit will remain in the operating condition that was in progress before the power cut.

Power failures will deactivate the TIMER mode: to reactivate the TIMER mode, press button C  twice.

Selection of the operating mode (button D)

This button selects the operating mode of the air conditioner. Different options are available depending on the unit model. By repeatedly pressing this button the available modes will be selected in sequence and the relevant symbols will appear on the display, while the unit will acknowledge signal receipt with a confirming "beep".

Symbol on display

 Cooling with dehumidification.

 Heating (where available).

A Automatic mode.
The air conditioner will automatically switch from heating (where available) to cooling and vice versa in order to maintain the selected temperature.

 Dehumidification only.
The air conditioner extracts moisture from the air without changing the room temperature.

 Ventilation (fan only).

Temperature control

 **UP**
(button E)

 **DOWN**
(button F)

Pressing the UP (E ) and DOWN (F ) buttons will increase or decrease the required room temperature value.

The unit will confirm the signal receipt with a "beep", and the value of the set temperature on the display will change accordingly. The temperature can be set between 18°C and 29°C at 1°C intervals.



In the cooling mode, if the temperature selected is higher than the room temperature the unit will not start. The same applies to the heating mode, if the selected temperature is lower than the room temperature.



Timer operating mode selection (button G)

By pressing button G  it is possible to choose one of the following programs in sequence:

Symbol on display

No symbol	Continuous operation (timer OFF)
-----------	----------------------------------

	Programmed start
	Programmed stop





	Combined program: unit will automatically cycle ON and OFF as programmed
	

Programmed start time

Press button G  until the symbol indicating programmed unit start appears on the display; select the desired starting time in the following manner:



- After having defined the TIMER program (in this case a programmed start) the last programmed time will appear on the display:

00:00

- A personalised new start time can be programmed by pressing buttons H  and I  until the desired time appears. Each press of the button will change the time by intervals of 15 minutes, from 0:00 to 23:45. Press button C  to confirm the selection: indicator P  on the unit will illuminate and the air conditioner is ready to start at the selected time. If the unit is in operation when the confirmation signal is sent (by pressing button C ) it will switch OFF and then restart at the new programmed start time.

Programmed stop time

Press button G  until the symbol indicating programmed unit stop appears on the display. Set the programmed stop time in the same manner as previously described.





Press button C  to confirm the selection. Indicator P  on the unit will illuminate and the unit will start. If the unit is switched OFF when the confirmation signal is sent (by pressing button C ) it will switch ON and then stop at the new programmed stop time.



40 GKX

Use of the remote control (if applicable)

Combined programming

The combined program (a selection of a sequence of start and stop times) will start and stop the air conditioner each day at the programmed times, without the need of user intervention. To activate this function proceed as follows:



1. Repeatedly press button G  until the programmed start symbol appears on the display; now set the desired start time, as indicated in the "programmed start time" section.
2. Press button G  again to show the symbol for the programmed stop time and set the desired stop time.
3. Press button G , until the symbol for the combined program appears; together with this symbol, the symbols for the start and stop programs appear alternatively along with the respective programmed times.
4. To confirm the program, press button C . Indicator P  on the unit will illuminate.
5. If the programmed times for start and stop coincide, the combined operation mode will not function.

The TIMER operation mode can be cancelled at any time by pressing button C : indicator P  on the unit will turn OFF, and the indication of the timer mode will disappear from the display on the remote control.

The unit will store the mode in which was operating at that time: ON if it was in operation, ON if it was turned OFF.





When the timer mode is ON (unit indicator P  illuminated) the remote control will always display the symbol relevant to the current timer program; the actual time will be displayed.

When a programmed start or stop has been selected, once the operation has been carried out at the desired time, the unit will remain in the TIMER operating mode selected. To change the operating mode, it is necessary to manually start or stop the unit or select a new program by pressing button C .

In the event of a power failure during timer mode operation, the unit will restart (when power is restored) and return to the last operating position before the power cut: unit indicator P  will flash to show that the Timer mode is OFF. To reactivate the timer mode, press button C  twice.

Time adjustment (buttons H and I)







To set the time for the timer programs selected with button G , press the buttons H  and I . Buttons H  and I  also serve to adjust the time shown on the display in the CLOCK section.

Selecting the fan speed (button J)

The fan speed can be selected by pressing button J .

Symbol on display

-  Low speed
(for night operation)
-  Medium speed
-  High speed
(to reach temperature)
-  Automatic
(Fan speed will automatically switch to the value required for optimum comfort). When this function is activated, the dotted symbols will flash.



Night stop (button K)

This function optimizes comfort at night, taking into account variations in the human metabolism.

One hour after activation of this function, the temperature (set for cooling) will increase by 1°C, or decrease by 1°C (if heating), up to 2°C in two hours. After 5 hours the unit will stop completely.

The system will automatically operate at low fan speed to minimize sound level.

When activating this function, the remote control will show the time when the air conditioner will completely stop.

Press button C  to deactivate the function.





Positioning the air outlet louvres (button L)

In order to optimise air distribution in the room, the air flow direction can be varied. By pressing button L  in sequence, the position of the louvres can be selected.

Symbol on display

-  Automatic
The air flow direction is controlled automatically. During cooling the deflecting louvres will direct the air close to the ceiling (Coanda effect); when heating, the air will be directed towards the floor in order to prevent layers of hot air forming in the upper part of the room.



Symbol on display

-  6 positions can be selected.
The louvres can be adjusted to provide 6 different air flow directions.
-  Swing
The louvres move continually from the bottom upwards in order to supply better air distribution.

Adjusting clock time (button M)

To adjust the clock time, put the remote control in the ON position by pressing button B  (after inserting the batteries).

To adjust the time shown in the CLOCK section, proceed as follows:

- Gently press the recessed button at the right corner of the remote control battery compartment with a pointed instrument (e.g. a pencil point): the hour figures will flash. Use buttons H  and I  to adjust their value to the correct time of day.
- Press the recessed button a second time and the minute figures will flash. Adjust them to the correct value in the same way.
- Pressing the recessed button a third time will activate the clock function.

40 GKX

Troubleshooting

After inserting the batteries in the remote control, the display does not illuminate:

- The batteries are exhausted or the polarity is incorrect; replace the batteries or check polarity.

When pressing the recessed clock adjustment button, the hour figures on the display do not flash:

- The recessed button has not been pressed correctly; press with a rounded point, avoid exerting excessive pressure.

When pressing any button all symbols appear on the display:

- The recessed button for time setting is blocked due to excessive pressure during use. The remote control has been irreversibly damaged; replace with a new one.

When pressing the start button, the unit does not acknowledge the signal with a “beep”:

- The main switch is switched OFF, place the switch in the ON position.
- The remote control batteries are exhausted; replace the batteries.
- The remote control has not been pointed correctly at the unit receiver; turn the remote control OFF and repeat the operation, pointing the remote control in the correct direction.
- There are obstacles (curtains, partitions, etc.) between the remote control and the unit; repeat the operation after having removed the obstacles.
- The receiver on the unit or the remote control is exposed to intense sun radiation; avoid direct sunlight on the unit, draw curtains or shut shades, or move the remote control.
- Signal transmission is obstructed by severe electromagnetic field interference; avoid sending signals when computers or household appliances (food processors, coffee makers, etc.) are operating close by. Cellular or cordless telephones may also interfere with the control.

When pressing the stop button the unit does not turn OFF and does not acknowledge the signal with a “beep”:

- The remote control batteries are exhausted; replace the batteries.
- The remote control has not been pointed correctly to the unit receiver; turn the remote control OFF and repeat the operation, pointing the remote control in the correct direction.
- There are obstacles (curtains, partitions, etc.) between the remote control and the unit; repeat the operation after having removed the obstacles.
- The receiver on unit or the remote control is exposed to intense sun radiation; avoid direct sunlight on the unit, draw curtains or shut shades, or move the remote control.
- Signal transmission is obstructed by severe electromagnetic field interference; avoid sending signals when computers or household appliances (food processors, coffee makers, etc.) are operating close by. Cellular or cordless telephones may also interfere with the control.

When pressing the stop button the unit acknowledges the signal with a “beep”, but the fan will not stop and LED Q (🔊) remains illuminated:

- Wait for 30 seconds, after which the unit will stop.

When pressing any function button, the remote control shows the function requested on the display, but the unit does not acknowledge the signal with a “beep” and does not carry out the function:

- The remote control batteries are exhausted; replace the batteries.
- The remote control has not been pointed correctly to the unit receiver; turn the remote control OFF and repeat the operation, pointing the remote control in the correct direction.
- There are obstacles (curtains, partitions, etc.) between the remote control and the unit; repeat the operation after having removed the obstacles.
- The receiver on unit or the remote control is exposed to intense sun radiation; avoid direct sunlight on the unit, draw curtains or shut shades, or move the remote control.
- Signal transmission is obstructed by severe electromagnetic field

interference; avoid sending signals when computers or household appliances (food processors, coffee makers, etc.) are operating close by. Cellular or cordless telephones may also interfere with the control.

The remote control display does not change when any button is pressed:

- The triangle symbol 1 ▲ is ON, whilst another signal is being transmitted; wait for signal 1 ▲ to disappear and then repeat the operation.

Air conditioner will not start:

- The main switch is switched OFF, place the switch in the ON position.
- The fuses on the main switch are burnt out; replace the fuses.
- Wait for 3 minutes: protection against frequent compressor cycling is ON.
- Selected temperature is higher than the room temperature (or lower in the heating mode).

Air conditioner is not supplying enough cooling (or heating):

- Air cannot circulate freely.
- Dirty filter reduces air quantity circulating.
- Doors and/or windows are open.
- Fan speed has been set to ‘low’.
- Air flow direction is not correct for optimum ventilation.
- Selected temperature is not correct.

A slight mist is emitted from the unit:

- A slight mist, coming out of the unit air outlet, is sometimes noticed during cooling operation. This is due to the cool air coming into contact with the room air.

A slight whistling noise is heard when the air conditioner starts or stops:

- This is due to the refrigerant beginning to circulate or an adjustment of the refrigerant pressures. This is a normal operating condition.

N (🔊) indicator is flashing:

System malfunction.

Contact service organisation after having ensured that:

- Air circulation is not obstructed.
- Outdoor unit coil is not obstructed and causing severe reduction of air circulation.
- Condensate drainage tube is not obstructed.

Restart air conditioner after having corrected the faults.

Q (🔊) indicator is illuminated:

- A unit protection device has been activated (see Table I).

The unit emits unpleasant smells:

- Unpleasant smells can accumulate on the air filters and then be dispersed into the room during air conditioner operation. Switch the unit OFF and contact an authorised service centre to have the filters cleaned. Restart unit in the ventilation (fan only) mode and open windows to change room air.

The unit makes strange noises:

- Occasionally the unit makes strange noises at start-up, during operation or when it has stopped. These are generally due to the effect of temperature changes on the plastic parts.

WARNING:

(models with electric heaters):

- If the manual reset, thermal trip device cuts out, switch the unit OFF and ON again at the main switch to reset. If the malfunction persists, contact your local authorised dealer.